



Iron CoaXPress 250

Iron CoaXPress Small Form Factor, Ruggedized Camera

Innovative Approach

The **Iron CoaXPress 250** is an ultra-thin high speed, low-cost, low-power global shutter CMOS camera with a micro-BNC interface which supports 5.01 MP high quality video at rates up to 155.5 fps.

Intelligent Design

Our camera incorporates Pregius's IMX250 global shutter sensor with a 3.45 μ m pixel size. With an extremely compact outline the **Iron** can be fitted into tight spaces. Superior sensor performance allows very low light vision capabilities.

Applications:

- Perimeter vision
- Low light surveillance
- Special Effects
- Virtual Reality
- 3D

Key Features:

- 5.01 Megapixel up to 155.5 fps
- Monochrome and Color models
- Up to 3.2W power at full rate
- Full image processing feature set
- Optional Pan/Tilt alignment of the sensor
- Up to 12.5 Gbps CoaXPress interface
- C, CS, F or EF mounts available
- Commercial and rugged industrial grade options
- Full EMVA1288 report
- Full built-in self-test (BIT)
- Full built-in voltage testing
- Customization as per user requirements

Technical Data

Feature	Description
Pixel Size	3.45 μm x 3.45 μm
Resolution	2448 (H) x 2048 (V)
Sensor Size	11.0 mm diagonal
Sensor	Sony Pregius IMX250 CMOS sensor
Output Interface	6.25 Gbps CoaXPress 1.1, 12.5 Gbps CoaXPress 2.0
Interface Connector	Micro-BNC
Output Resolution	8, 10 or 12 bit
Max Frame Rate	155.5 fps @8 bit resolution 133.3 fps @10 bit resolution 84.8 fps @12 bit resolution
Image Acquisition	Continuous / Triggered
Camera Control	GenCam
Electronic Shutter	Global shutter
Sensor Positioning	Full pan/tilt calibration for optical axes (optional)
Monochrome/ Color	Monochrome / Color
Temporal Noise	< 2.2 e ⁻ @25°C
Full Well Charge	9828 e ⁻
Dynamic Range	> 70.8dB @520nm
Signal-to-Noise Ratio (SNR max)	40 dB @520nm
Quantum Efficiency (QE) X FF	> 63% @525nm
Shortest Exposure	10 μs
On camera processing	<ul style="list-style-type: none"> ▪ Defect pixel correction ▪ ROI ▪ Frame counter ▪ Flat field / Fixed patter noise correction ▪ Auto/Manual black level ▪ Auto Exposure/Gain ▪ Auto/Manual White balance ▪ Image flip ▪ LUT ▪ Gain (Analog / Digital) ▪ Binning ▪ Operational Time Counter
GPIO Connection	Two inputs, two outputs, external trigger & strobe controller (optional)

Mechanical & Electrical

Feature	Description
Dimensions (including lens mount)	Commercial: 44 mm x 44 mm x 35.3 mm (Height x Width x Depth) Industrial: 44 mm x 44 mm x 35.1 mm (Height x Width x Depth)
Weight (without lens)	Commercial: ~50g Industrial: ~90g
Operating Temperature	Commercial: 0°C to 50°C, 20-85% humidity (non-condensing) Industrial: -40°C to 80°C, 20-85% humidity (non-condensing)
Storage Temperature	Commercial: 0°C to 55°C, 20-85% humidity (non-condensing) Industrial: -40°C to 85°C, 20-85% humidity (non-condensing)
Operational Shock	Tested per MIL-STD-810G Method 516.6, 3-axis Shock 75G
Operational Vibration	Tested per MIL-STD-810G Method 514.6, 3-axis Vibration Category 20
Ingress Protection	Optional IP67 (with protective lens tube)
Lens Mount	C-mount, CS-mount, F-mount or EF-mount
Power Input	PoCXP full support (11-28V with external power option)
Power Consumption	<3.2W @ 24V DC

* KAYA Instruments reserves the right to update the data sheet from time to time without prior notice.

Ordering Information

KAYA's Part Numbers are intuitive and derived directly from the product's properties. Each index represents a different property of the camera, according to the following diagram:

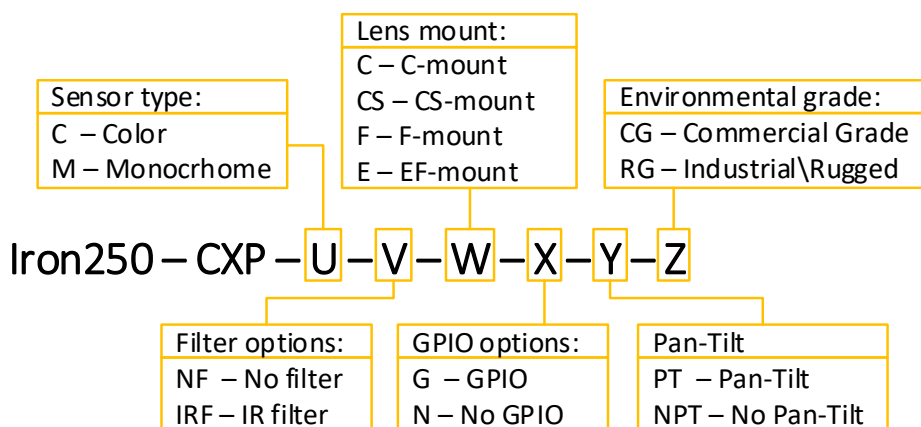

For example: an Iron CoaXPress 250 with a colored sensor, UV-IR cut filter and C-mount, with no GPIO or pan-tilt that is rated for commercial use would go by Iron250-C-IRF-C-N-NPT-CG. Please contact a sales representative over at info@kayainstruments.com for a full list of peripherals including cables and frame grabbers.

Absolute Quantum Efficiency

Pregius's IMX250 Mono Spectral Response

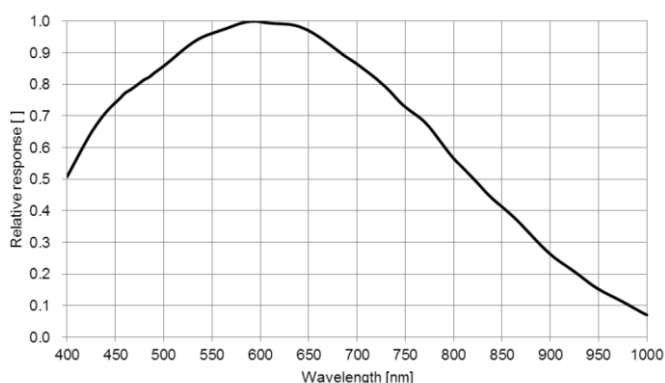

Pregius's IMX250 Color Spectral Response

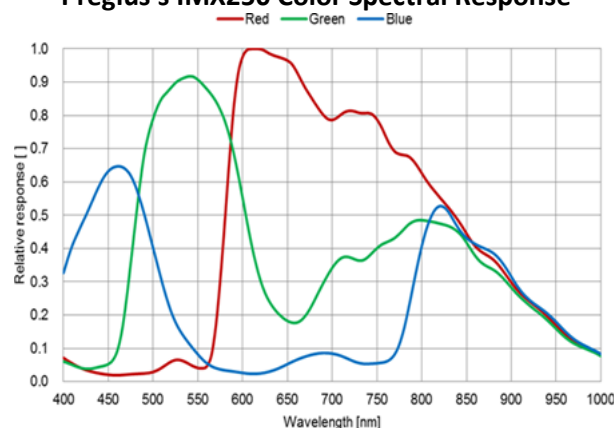

General Purpose Input Output

GPIO Pinout – 12 Pin Hirose Connector

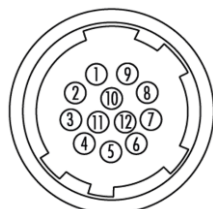

- | | |
|-----------------------|-------------------------|
| 1. DC Power return | 7. OUT1 (TTL) |
| 2. DC Power | 8. IN1 (TTL) |
| 3. RS232 RX | 9. IN2 (LVTTTL) |
| 4. RS232 TX | 10. IN1/OUT1 Return |
| 5. OUT2 Return (OPTO) | 11. IN2 Return (LVTTTL) |
| 6. RS232 Return | 12. OUT2 (OPTO) |

The GPIO connector used on the camera is a 12 pin male Hirose connector. It is recommended to use a cable with a matching Hirose 12 pin female connector. Hirose's manufacturer's part number is listed below:

Product Name	Product Part Number
Hirose 12P connector, male	HR10A-10R-12PB
Hirose 12P connector, female	HR10A-10P-12S

Mechanical Drawings

Commercial grade, no GPIO:

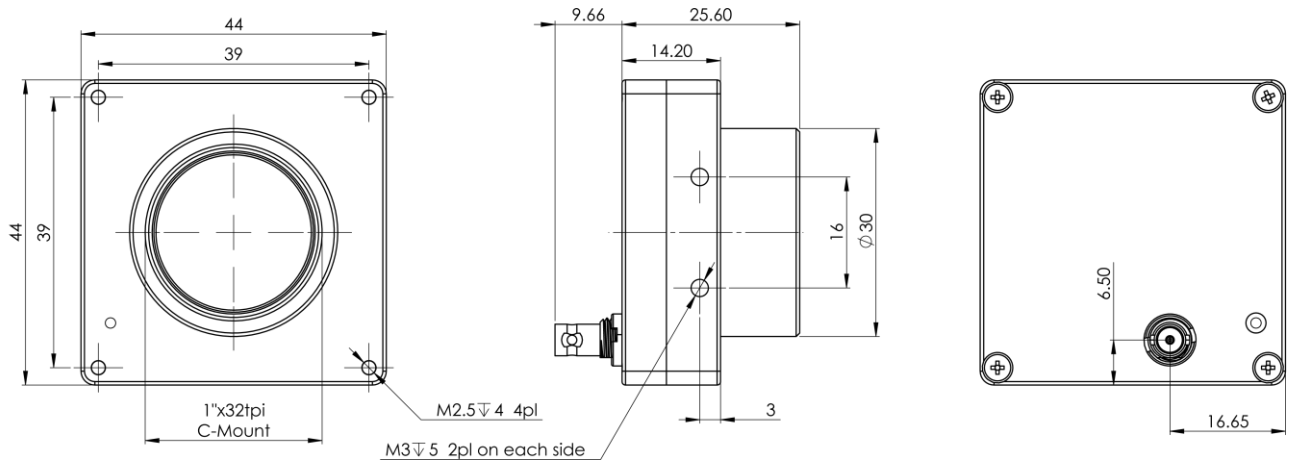

Commercial grade, with GPIO:

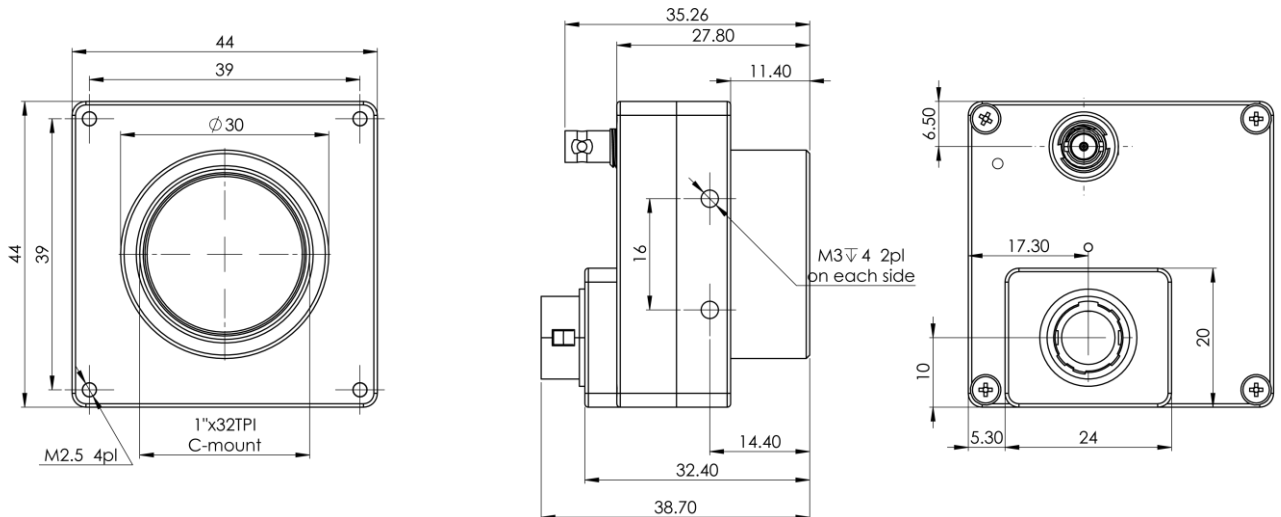

Industrial grade, no GPIO:

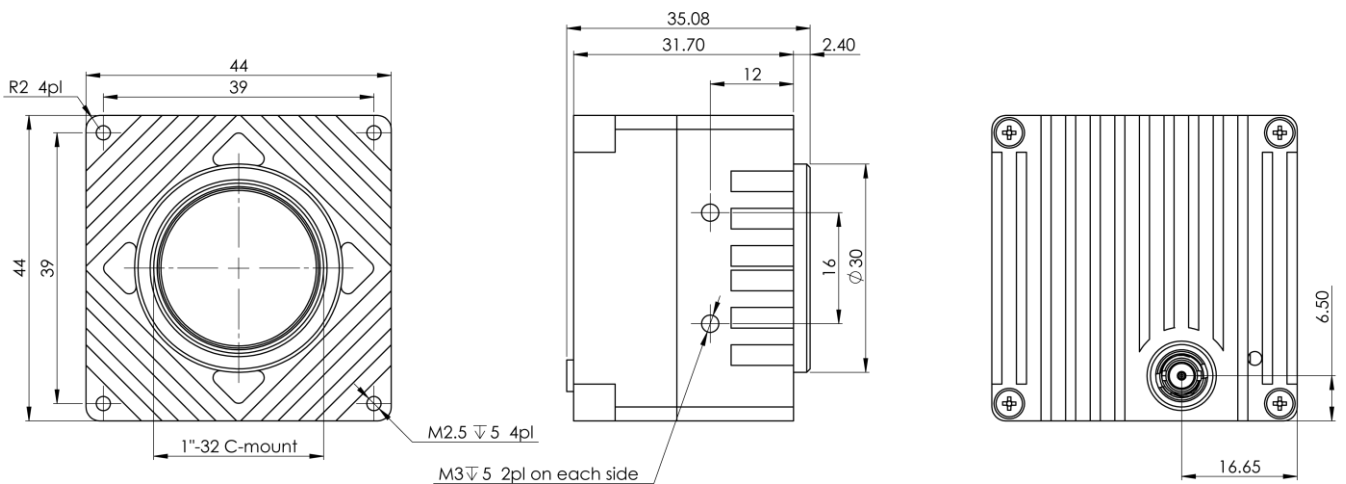

Industrial grade, with GPIO:

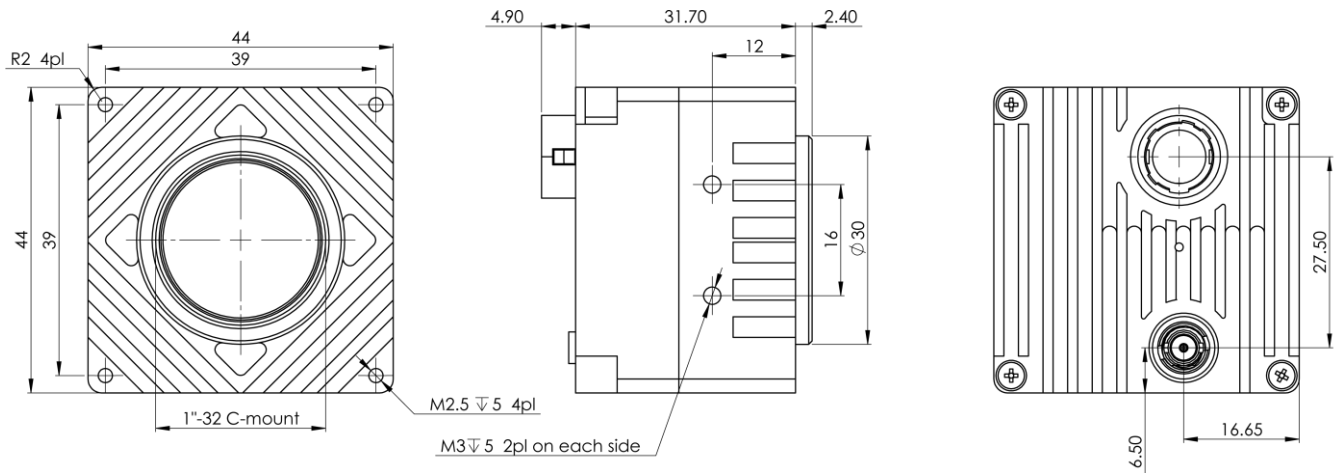

Compatibility

KAYA Instruments creates and maintains compatibility and interfaces for the most common and advanced vision image processing libraries and applications.

Major support is available for **MVTec Halcon**, **National Instruments' LabVIEW** and **MathWorks' MATLAB**.

❖ Supported vision standards:



❖ Supported vision libraries:



❖ Supported operating systems:



Please check our website for an up-to-date list of other supported libraries and software package

Contact Us

Please feel free to contact our team with any question or further inquiry at info@kayainstruments.com – we will be happy to provide assistance and consultation.

KAYA Instruments

20 HaMesila St., Neshet 3688520, Israel
POB 25004, Haifa 3125001, Israel

Tel: +972-72-272-3500
Fax: +972-72-272-3511



© 2017 KAYA Instruments, Inc. All rights reserved. KAYA Instruments, the KAYA Instruments Komodo logo, JetCam logo, Predator, Iron and combinations thereof are trademarks of KAYA Instruments, Inc. in the United States and/or other jurisdictions. Microsoft Windows is a registered trademark of Microsoft Corporation. Other names are for informational purposes only and may be trademarks of their respective owners. KAYA Instruments is not liable for harm or damage incurred by information contained in this document

